



PCV Oil Catch Can System

Step-by-Step Installation Instructions

CONGRATULATIONS! – Thank you for purchasing **Elite Engineering's (E²) PCV Oil Catch Can System!** We have confidence that you will be totally satisfied with the construction, function and looks of the E² System.

IMPORTANT – Please read through these instructions completely before starting installation. Be sure **all** Catch Can fittings are tight prior to installation. And be sure the condensation trap (Internal Diffuser) has Blue Locktite or similar on the threads to ensure it does not become loose during normal use.

NEEDED TOOLS – Allen head wrenches, pliers and a sharp knife.

1) Remove the RH side (passenger's side) valve cover plastic shield by removing the oil filler cap and then carefully pulling the cover upward. After the cover is removed, reinstall the oil filler cap to prevent any debris from entering the engine. **Note:** Removing the valve cover shield makes the installation easier, especially on the LS1.

2) Configure the OEM PCV hoses as follows:

1997 – 2003 LS1

- Carefully remove the short hose located between the PCV valve and the front RH side of the intake manifold.

2001 – 2003 LS6

- Carefully remove the U-shaped hard plastic tube from the PCV valve near the front RH side of the intake manifold. Then remove the rubber hose that the U-shaped tube is in from the metal fitting located on the RH front corner of the valley cover.

2004+ LS1, LS6 and LS2

- Carefully remove the short rubber hose located between the metal fitting located on the RH front corner of the valley cover and the front RH side of the intake manifold.

3) Attach the mounting bracket to the Catch Can with the supplied stainless steel fasteners, and tighten securely. **Note:** Some Catch Cans may arrive with the mounting bracket already attached.

4) (**Reference Figure 1**) Locate the Catch Can and Bracket Assembly on the RH front end of the engine head, and attach with the supplied stainless steel 10 mm dia. by 20 mm long button head

bolts and washers. **Note:** Pull the mounting bracket up & out as far as the bolt slots will allow, to make adequate clearance at bottom of Catch Can. Tighten to 18 ft-lbs.

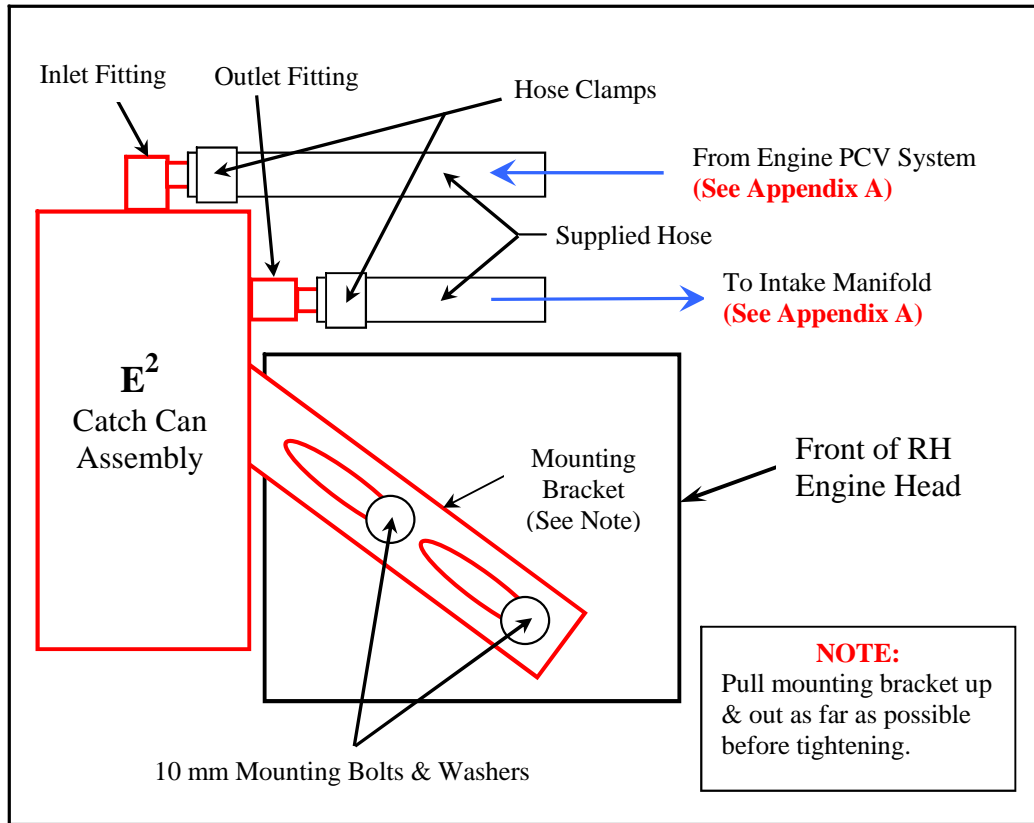

Figure 1 – Catch Can Assembly Mounting Setup

5) (**Reference Appendix A**) Using the supplied 3/8" ID hose, determine the required Catch Can inlet and outlet hose lengths for your specific engine application by pre-routing the hoses before cutting. **Note:** Ensure hose length and routing prevents any hose kinking. Cut hose to required length.

6) Attach the Catch Can hoses as follows – refer to your specific engine application below:

1997 – 2003 LS1

- (**Reference Figure 2**) Slide a supplied hose clamp over each end of the hoses cut above. Connect the hose from the OEM PCV valve to the Catch Can inlet fitting (top location). Connect the other hose from the Catch Can outlet fitting (side location) to the intake manifold hose fitting. Reposition hose clamps to ensure a good seal.

2001 – 2003 LS6

- (**Reference Figure 3**) Slide a supplied hose clamp over each end of the hoses cut above. Connect the hose from the valley cover hose fitting to the Catch Can inlet fitting (top location). Install the supplied 3/8" OD by 1.0" long adaptor tube half way into the OEM

PCV valve assembly's rubber fitting. Connect the other hose from the Catch Can outlet fitting (side location) to the adaptor tube at the PCV valve. Reposition hose clamps to ensure a good seal, while noting the specific clamp location at the adaptor tube connection.

2004+ LS1, LS6 and LS2

NOTE

2004 and beyond LS1, LS6 and LS2 engines do not have an external PCV valve, but rather a built in 2.5 mm diameter orifice into the valley cover outlet hose fitting. No figure is shown for this setup.

- Slide a supplied hose clamp over each end of the hoses cut above. Connect the hose from the valley cover hose fitting to the Catch Can inlet fitting (top location). Connect the other hose from the Catch Can outlet fitting (side location) to the intake manifold hose fitting. Reposition hose clamps to ensure a good seal.

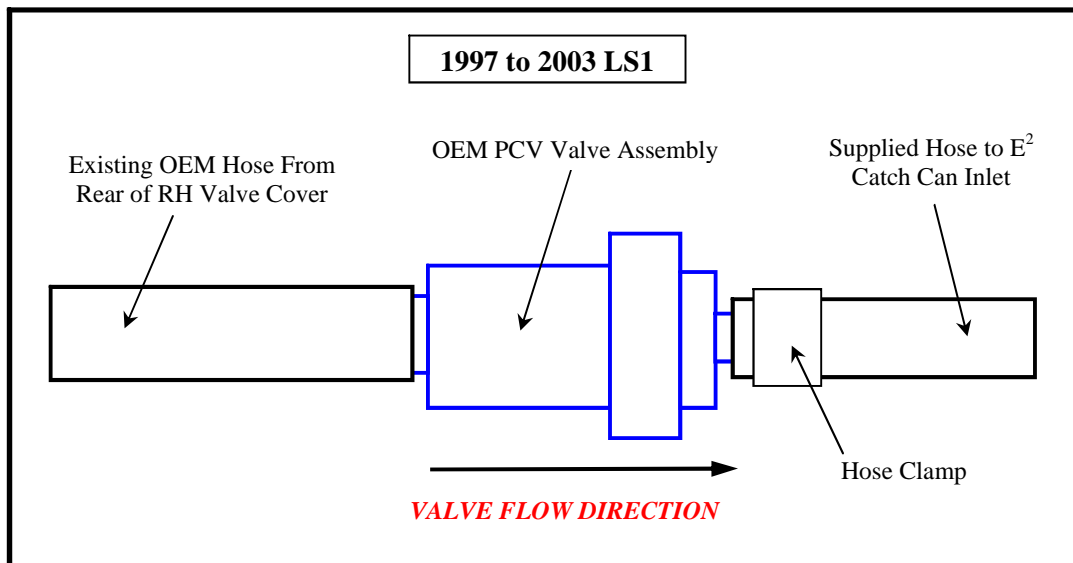

Figure 2 – LS1 PCV Valve Configuration

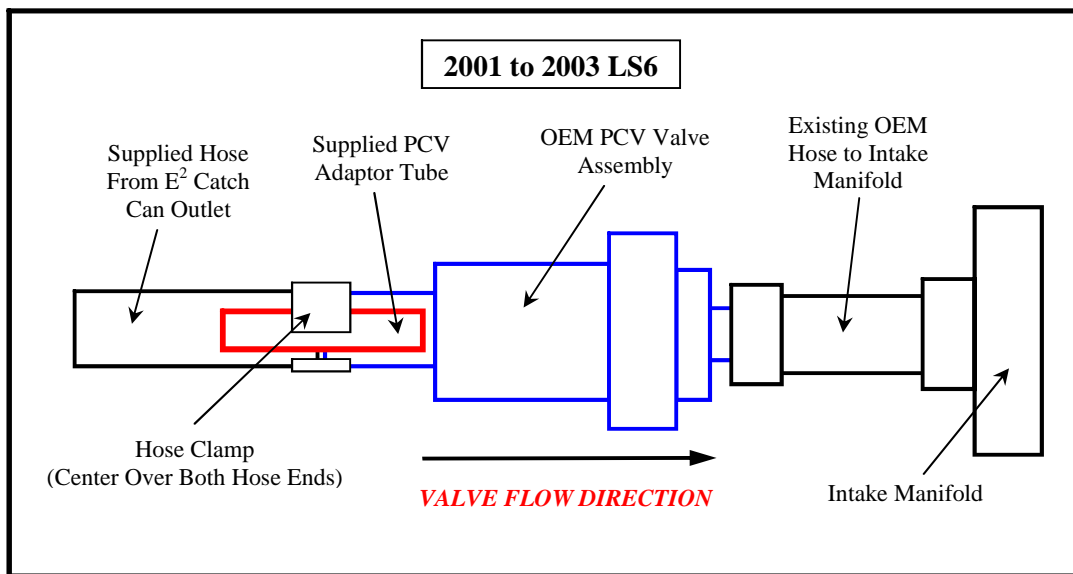

Figure 3 – LS6 PCV Valve Configuration

7) If the RH valve cover plastic shield was removed in Step 1, reinstall in reverse order of removal.

Catch Can Service and Maintenance

The E² Catch Can will effectively separate oil from the vapors pulled from the crankcase by the PCV system, and will accumulate liquid oil in the removable bottom section. The Catch Can is designed to be serviced periodically, and the frequency of service will primarily depend on how hard the car is driven. If used in competitive driving events, the Catch Can should be checked and serviced after every event.

To service the Catch Can, simply unscrew the bottom reservoir section and carefully remove it from the car for emptying and cleaning.

NOTE

Use some of the collected oil to keep the threads and O-ring lubricated. When reinstalling the bottom reservoir section, tighten by hand only to ensure easy future removal.

If required, the condensation trap's stainless steel mesh material can be removed for inspection, cleaning or replacement. Normally this will not be necessary, and is only recommend if the performance of the Catch Can has become noticeably reduced under the same conditions of use.

To remove the condensation trap (Diffuser) assembly, first remove the Catch Can Assembly from the vehicle for easier servicing. Unscrew the bottom reservoir section to gain access to the condensation trap located inside the top of the Catch Can. Grasp the ventilated cover to unscrew the condensation trap assembly from the top section, and remove the stainless steel mesh material. This removal may be difficult due to the Blue Locktite used during the first assembly. Blue Locktite or similar is recommended on the Diffuser Threads to ensure the condensation trap (diffuser) does not become loose during normal use. Clean components if required and reassemble in reverse order of removal. Be careful to not damage the stainless mesh material. Tighten the ventilated cover assembly with Blue Locktite by hand only to ensure easy future removal.

The anodized exterior surfaces of the Catch Can and Mounting Bracket are corrosion resistant, and no special maintenance is required.

Appendix A

PCV Oil Catch Can Hose Schematics

There are three different PCV hose layouts used on the LS1, LS6 and LS2 engines as follows:

1997 thru 2003 LS1 – PCV system removes crankcase vapors off both valve covers. An external PCV valve regulates flow.

2001 thru 2003 LS6 – PCV system removes crankcase vapors off the valley cover. An external PCV valve regulates flow.

2004 and beyond LS1, LS6 and LS2 – PCV system removes crankcase vapors off the valley cover. A non-removable 2.5 mm orifice built into the valley cover hose fitting regulates flow.

Systems Schematic Key

Note: Schematics are shown with Catch Can installed. Exact location of hardware is not represented.

- 1) Valve Covers
- 2) Valley Cover
- 3) Intake Manifold (front section)
- 4) Throttle Body Assembly
- 5) PCV Valve (pre 2004) or PCV Orifice in Valley Cover Hose Fitting (2004+)
- 6) Elite Engineering (E²) PCV Oil Catch Can
- 7) Crankcase Vapor Source
- 8) Crankcase Clean Makeup Air Source (**Note:** Do not disturb this hose)

NOTE

The Catch Can and supplied 3/8" ID hoses are shown in **RED**. Hoses & PCV valves shown in **GREEN** and **GREY** are retained OEM PCV system parts.

1997 – 2003 LS1 Setup

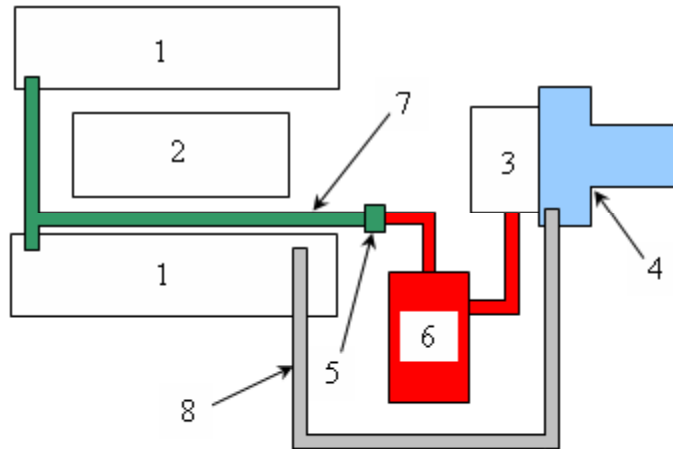

2001 – 2003 LS6 Setup

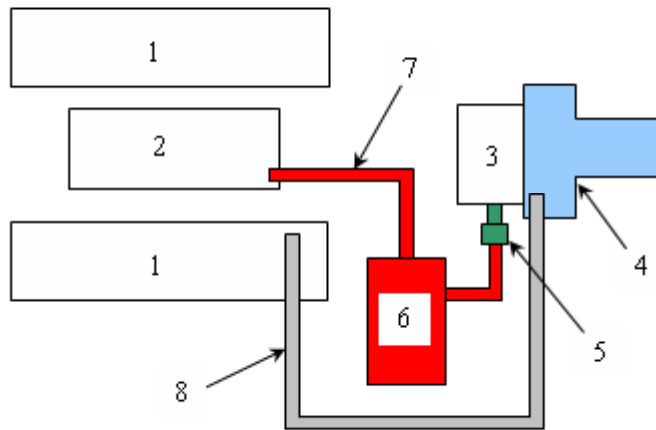

2004+ LS1, LS6 and LS2 Setup

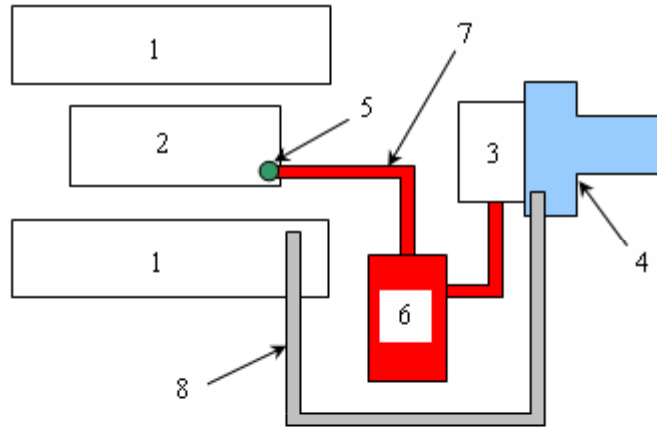

Note: Hose #8 Connects to Air Intake Bridge Instead of Throttle Body on LS2 Engines.

***** PRIOR TO INSTALLATION, BE SURE ALL HOSE BARB FITTINGS AND BRACKET SCREWS ARE INSTALLED AND TIGHT**

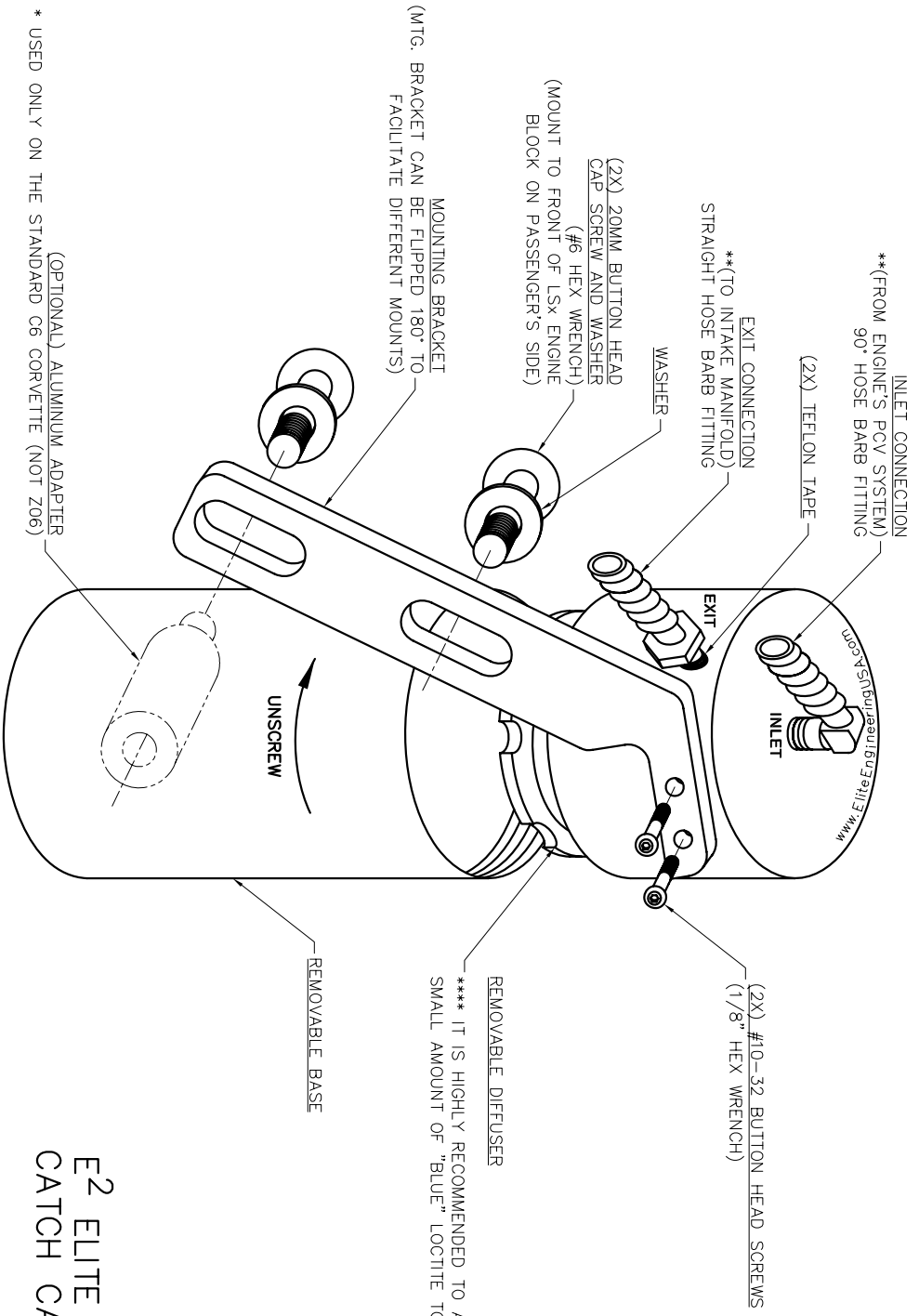

* USED ONLY ON THE STANDARD C6 CORVETTE (NOT Z06)
(OPTIONAL) ALUMINUM ADAPTER

REMOVABLE DIFFUSER
***** IT IS HIGHLY RECOMMENDED TO APPLY A SMALL AMOUNT OF "BLUE" LOCTITE TO THREADS ON DIFFUSER) *****

**E² ELITE ENGINEERING
CATCH CAN ASSEMBLY**

- NOTES:**
1. UNLESS OTHERWISE SPECIFIED, ALL DIMENSIONS ARE IN INCHES.
 2. INTERPRET DRAWING IN ACCORDANCE WITH ANSI Y14.5.
 3. BREAK ALL SHARP EDGES AND DEBURR.
 4. MATERIAL: NOTED
 5. DETAILED INSTALLATION INSTRUCTIONS AND PICTURES CAN BE FOUND ON OUR WEBSITE AT: www.EliteEngineeringUSA.com
 6. CATCH CAN VOLUME: 9.58 OZ.

PROPRIETARY NOTE:

THIS DOCUMENT CONTAINS PROPRIETARY INFORMATION OF ELITE ENGINEERING, LLC. NEITHER RECEIPT NOR POSSESSION THEREOF CONFERES ANY RIGHT TO REPRODUCE OR USE, OR DISCLOSE, IN WHOLE OR IN PART, ANY SUCH INFORMATION WITHOUT WRITTEN AUTHORIZATION.

E² Elite Engineering, LLC

1555 Main Street Suite A3 #225
Windsor, CO. 80550
Telephone Sales: 877-VETTE-11 (838-8311)
Email: sales@EliteEngineeringUSA.com
Website: www.EliteEngineeringUSA.com

DATE	JUNE 9, 2004	SCALE		SHEET	1 OF 1
REV		SIZE	SCALE NO.	DWG NO.	CC-ASSEMBLY